

Standing Seam fixed and sliding clips

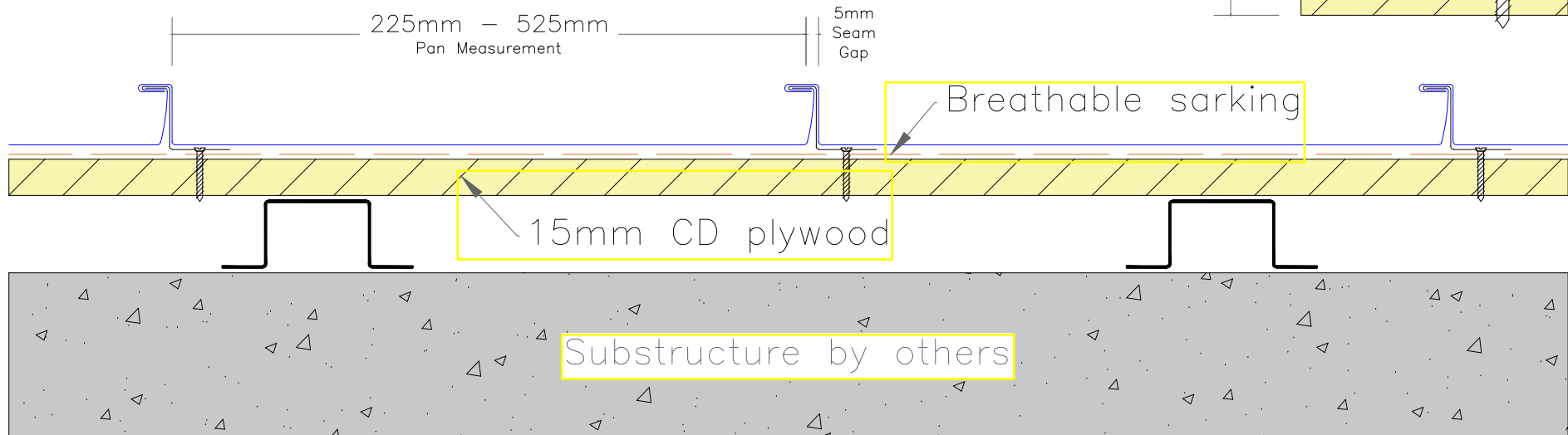
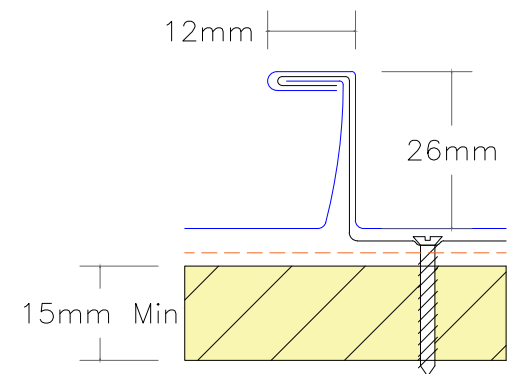

Zinc Roofing Company Pty Ltd TA Euroclad
 ABN: 45 297 371 439
 3/328 Brisbane Road Arundel QLD 4214
 Tel: (07) 5537 1937
 Email: info@euroclad.com.au

- NOTES:**
1. All dimensions shown are in millimeters unless otherwise stated.
 2. Figured dimensions to be used in preference to scaled dimensions.
 3. Ensure compliance with all relevant sections of current building regulations.
 4. Any discrepancies found on drawings to be reported immediately to Euroclad.
 5. Not a shop drawing. For illustration purposes only.

DRAWING # SS-HC-01	REVISION # 0	SYSTEM	Single Lock Standing Seam Horizontal
		TITLE	General cross section
		SCALE	NTS

DATE : N/A	DRN : NP	JOB # 0	PROJ # 0
-------------------	-----------------	----------------	-----------------

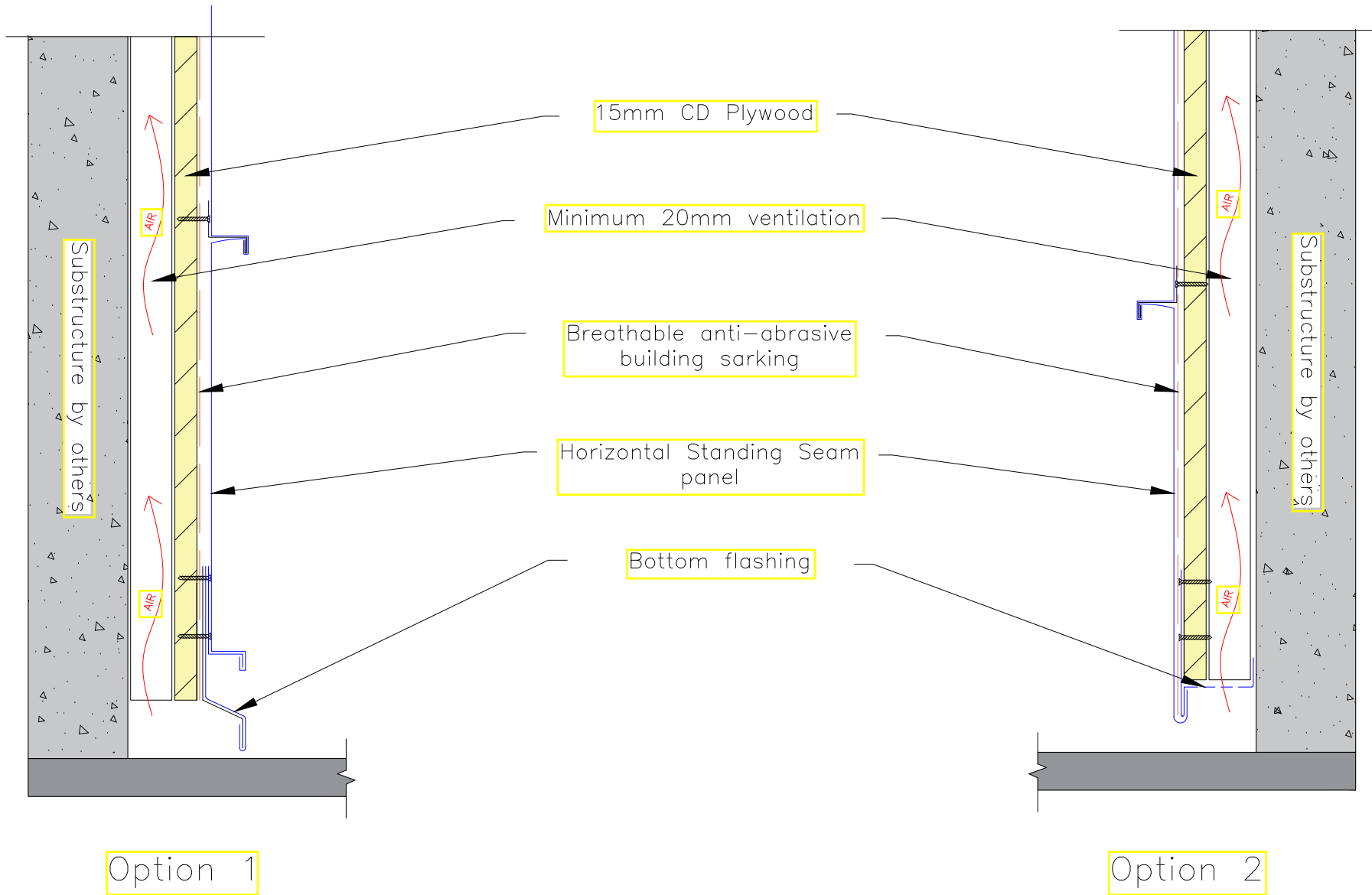

Zinc Roofing Company Pty Ltd TA Euroclad
 ABN: 45 297 371 439
 3/328 Brisbane Road Arundel QLD 4214
 Tel: (07) 5537 1937
 Email: info@euroclad.com.au

NOTES:
 1. All dimensions shown are in millimeters unless otherwise stated.
 2. Figured dimensions to be used in preference to scaled dimensions.
 3. Ensure compliance with all relevant sections of current building regulations.
 4. Any discrepancies found on drawings to be reported immediately to Euroclad.
 5. Not a shop drawing. For illustration purposes only.

DRAWING #
 SS-HC-02

REVISION #
 0

SYSTEM	Single Lock Standing Seam Horizontal
TITLE	Typical Bottom flashing detail
SCALE	NTS

DATE: N/A

DRN: NP

JOB # 0

PROJ # 0

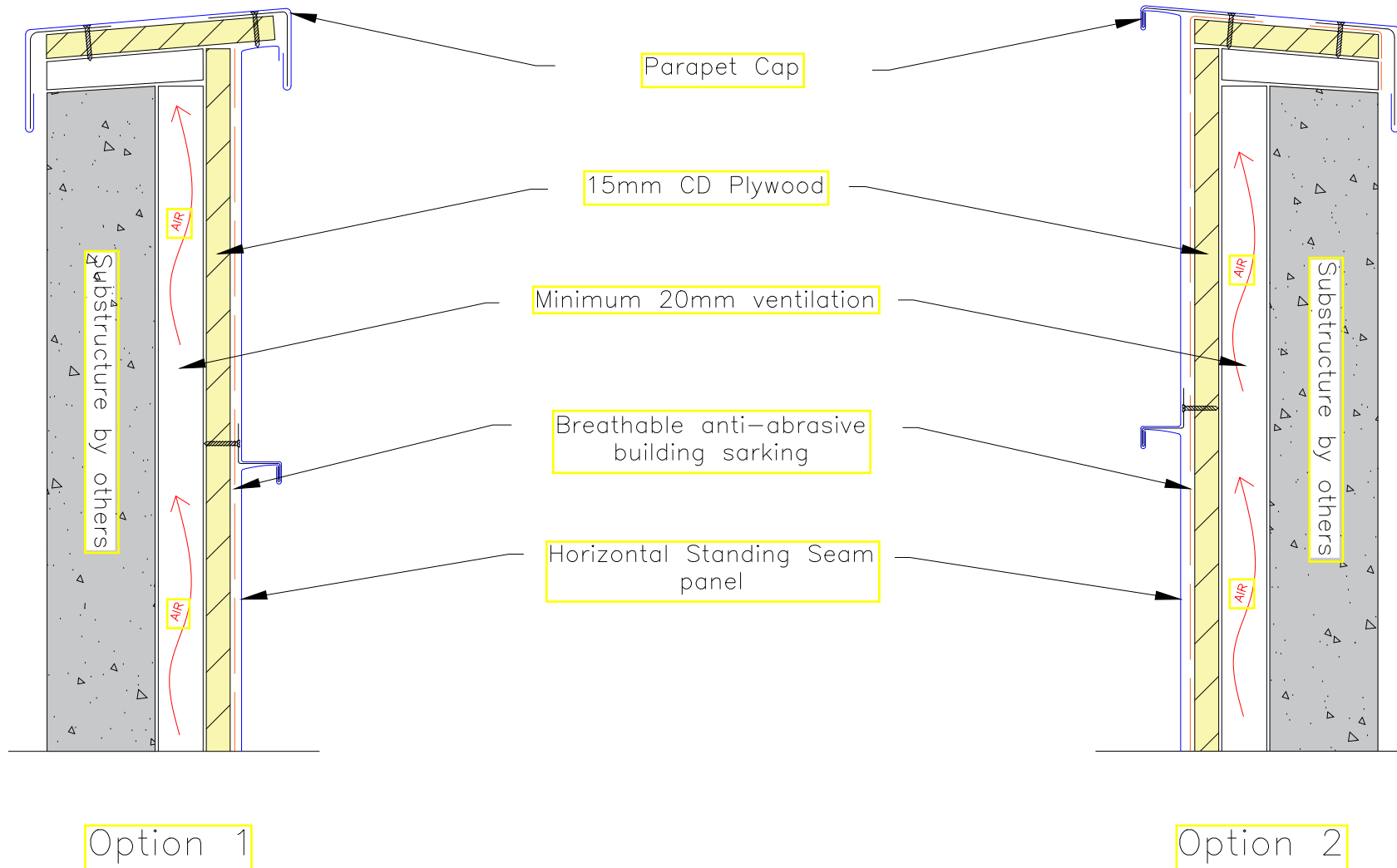

Zinc Roofing Company Pty Ltd TA Euroclad
 ABN: 45 297 371 439
 3/328 Brisbane Road Arundel QLD 4214
 Tel: (07) 5537 1937
 Email: info@euroclad.com.au

NOTES:

1. All dimensions shown are in millimeters unless otherwise stated.
2. Figured dimensions to be used in preference to scaled dimensions.
3. Ensure compliance with all relevant sections of current building regulations.
4. Any discrepancies found on drawings to be reported immediately to Euroclad.
5. Not a shop drawing. For illustration purposes only.

DRAWING #
SS-HC-03

REVISION #
0

SYSTEM	Single Lock Standing Seam Horizontal
TITLE	Typical Parapet detail
SCALE	NTS

DATE: N/A

DRN: NP

JOB # 0

PROJ # 0

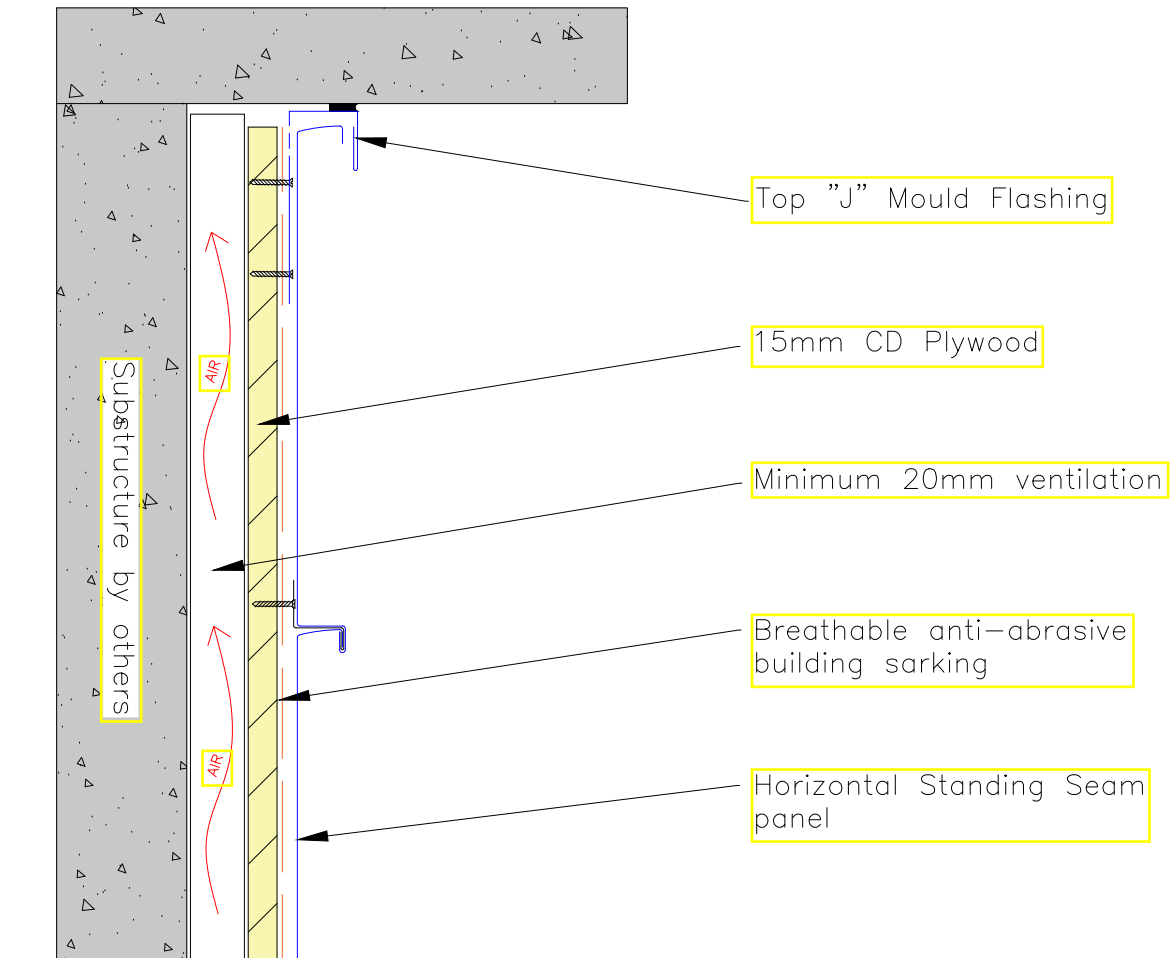

NOTES:

1. All dimensions shown are in millimeters unless otherwise stated.
2. Figured dimensions to be used in preference to scaled dimensions.
3. Ensure compliance with all relevant sections of current building regulations.
4. Any discrepancies found on drawings to be reported immediately to Euroclad.
5. Not a shop drawing. For illustration purposes only.

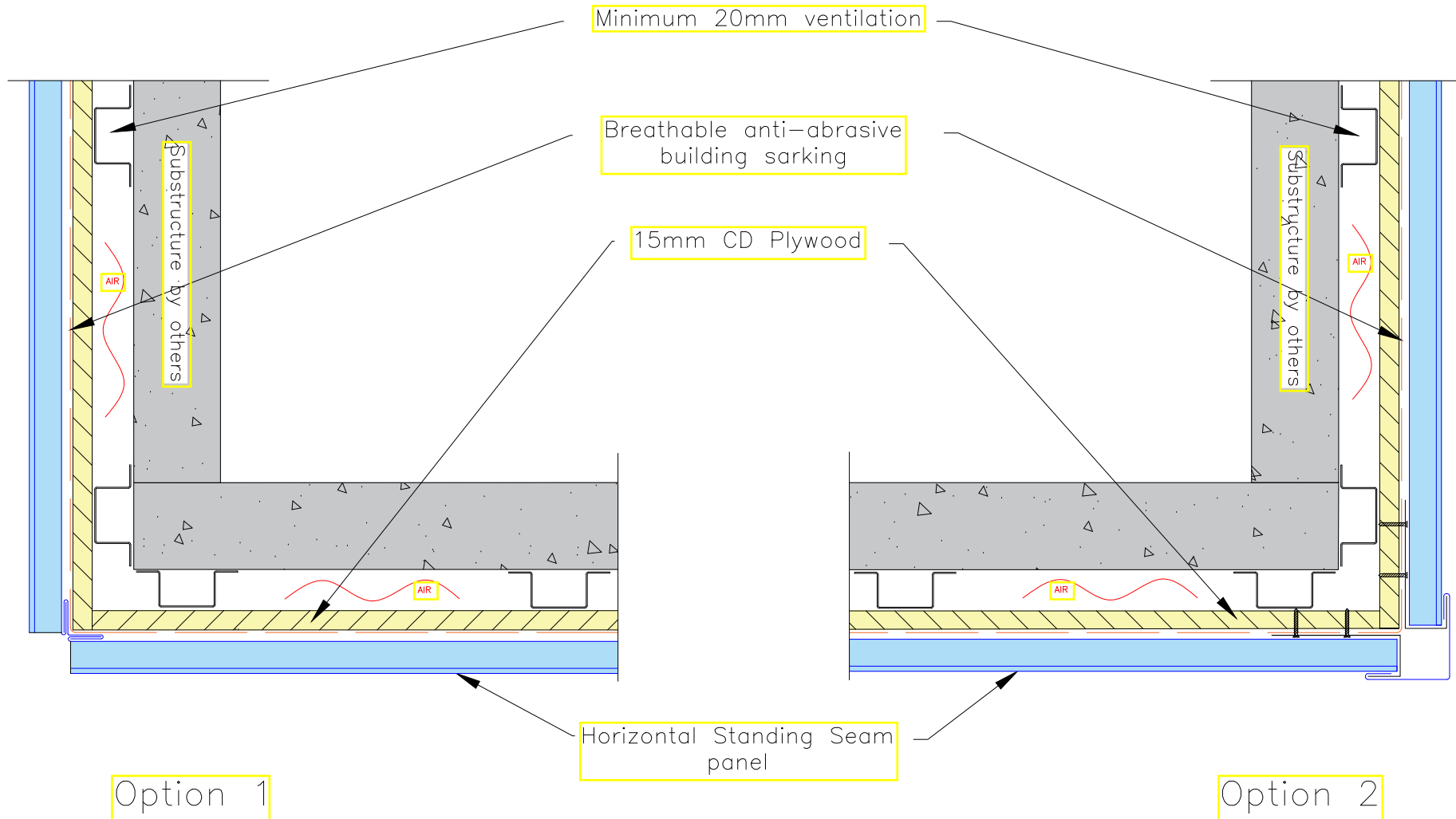

Zinc Roofing Company Pty Ltd TA Euroclad
 ABN: 45 297 371 439
 3/328 Brisbane Road Arundel QLD 4214
 Tel: (07) 5537 1937
 Email: info@euroclad.com.au

DATE: N/A

DRN: NP

NOTES:

1. All dimensions shown are in millimeters unless otherwise stated.
2. Figured dimensions to be used in preference to scaled dimensions.
3. Ensure compliance with all relevant sections of current building regulations.
4. Any discrepancies found on drawings to be reported immediately to Euroclad.
5. Not a shop drawing. For illustration purposes only.

JOB # 0

PROJ # 0

DRAWING #

SS-HC-05

REVISION #

0

SYSTEM

Single Lock Standing Seam Horizontal

TITLE

Typical external corner detail

SCALE

NTS

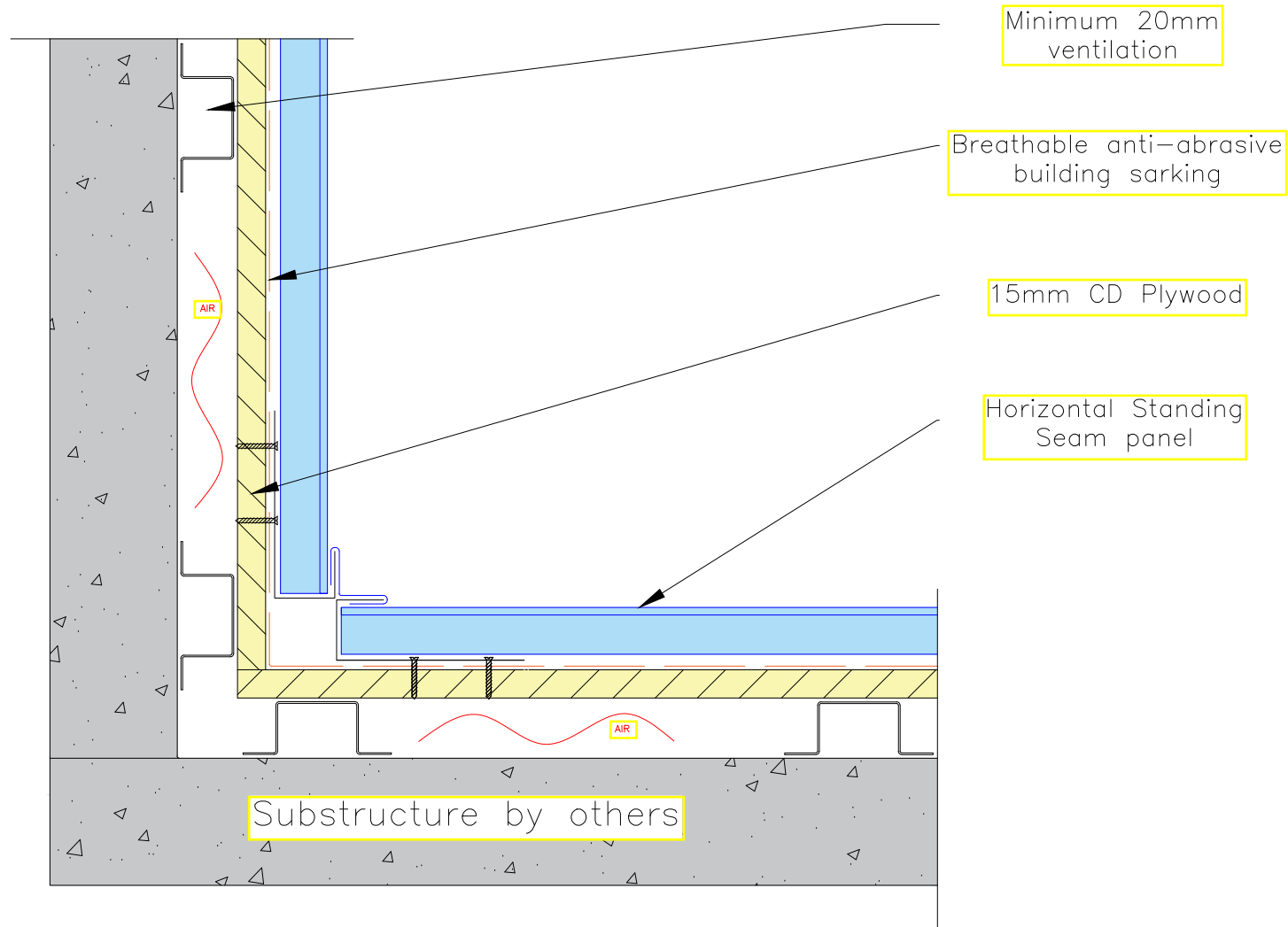

Zinc Roofing Company Pty Ltd TA Euroclad
 ABN: 45 297 371 439
 3/328 Brisbane Road Arundel QLD 4214
 Tel: (07) 5537 1937
 Email: info@euroclad.com.au

NOTES:

1. All dimensions shown are in millimeters unless otherwise stated.
2. Figured dimensions to be used in preference to scaled dimensions.
3. Ensure compliance with all relevant sections of current building regulations.
4. Any discrepancies found on drawings to be reported immediately to Euroclad.
5. Not a shop drawing. For illustration purposes only.

DRAWING #

SS-HC-06

REVISION #

0

SYSTEM

Single Lock Standing Seam Horizontal

TITLE

Typical internal corner detail

SCALE

NTS

DATE: N/A

DRN: NP

JOB # 0

PROJ # 0

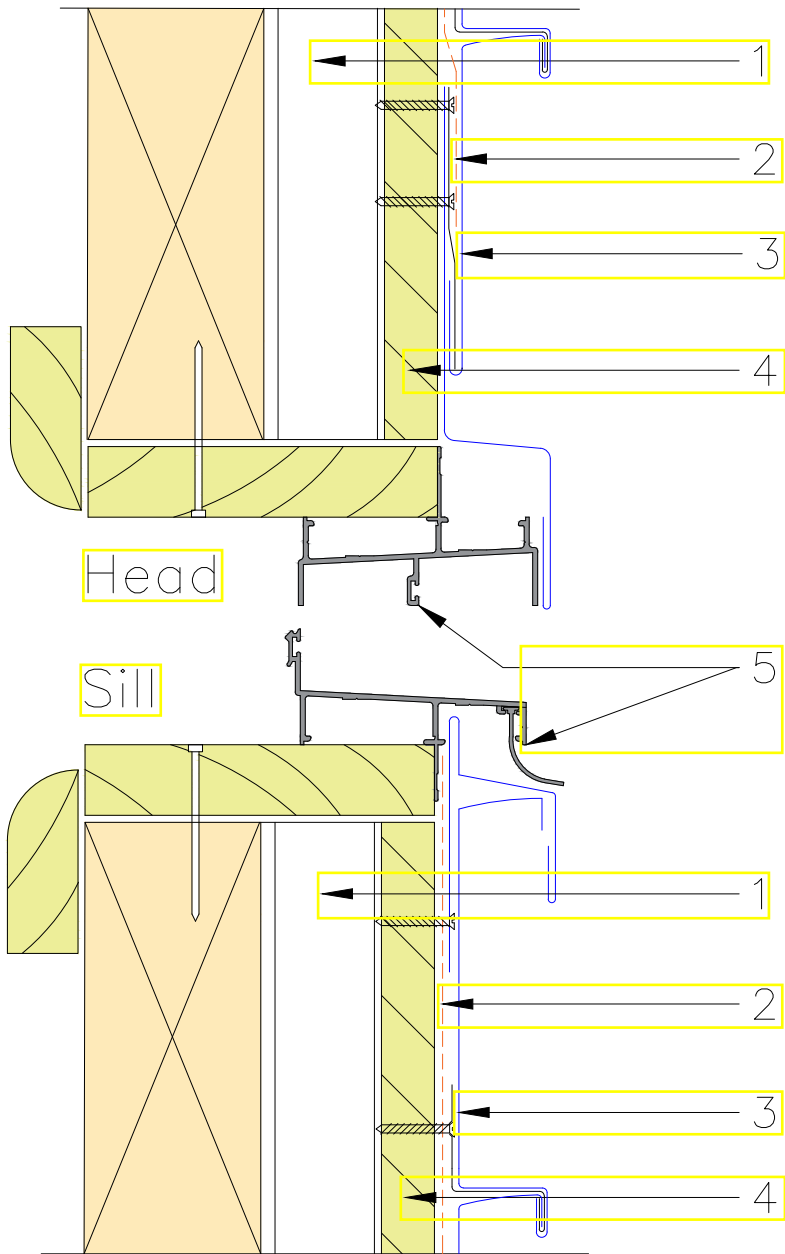

Typical
timber reveal
window detail

1 Minimum 20mm
ventilation

2 Breathable
anti-abrasive building
sarking

3 Horizontal Standing
Seam panel

4 15mm CD Plywood

5 Window supplied by
others

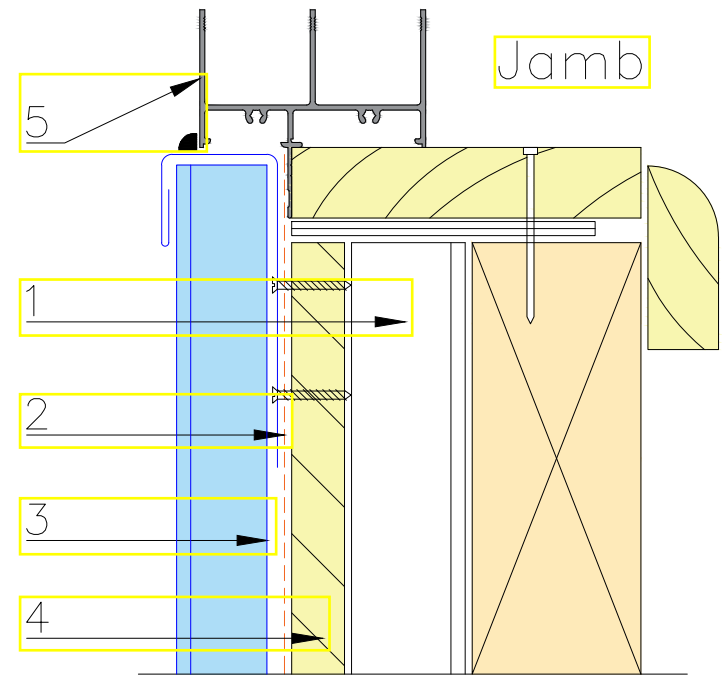

Zinc Roofing Company Pty Ltd TA Euroclad
ABN: 45 297 371 439
3/328 Brisbane Road Arundel QLD 4214
Tel: (07) 5537 1937
Email: info@euroclad.com.au

NOTES:

1. All dimensions shown are in millimeters unless otherwise stated.
2. Figured dimensions to be used in preference to scaled dimensions.
3. Ensure compliance with all relevant sections of current building regulations.
4. Any discrepancies found on drawings to be reported immediately to Euroclad.
5. Not a shop drawing. For illustration purposes only.

DRAWING #
SS-HC-07

REVISION #
0

SYSTEM Single Lock Standing Seam Horizontal
TITLE Window Surroundings

DATE: N/A

DRN: NP

JOB # 0

PROJ # 0

SCALE NTS

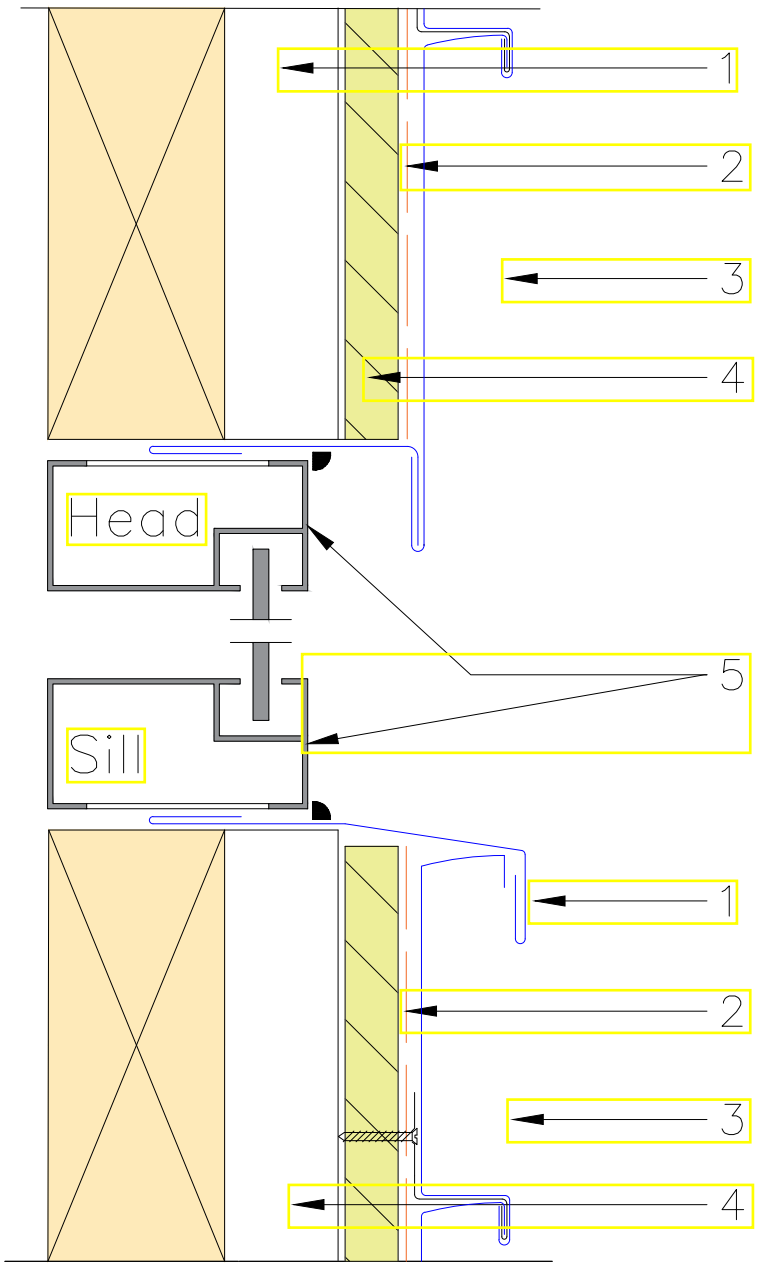

Typical window detail

- 1 Minimum 20mm ventilation
- 2 Breathable anti-abrasive building sarking
- 3 Horizontal Standing Seam panel
- 4 15mm CD Plywood
- 5 Window supplied by others

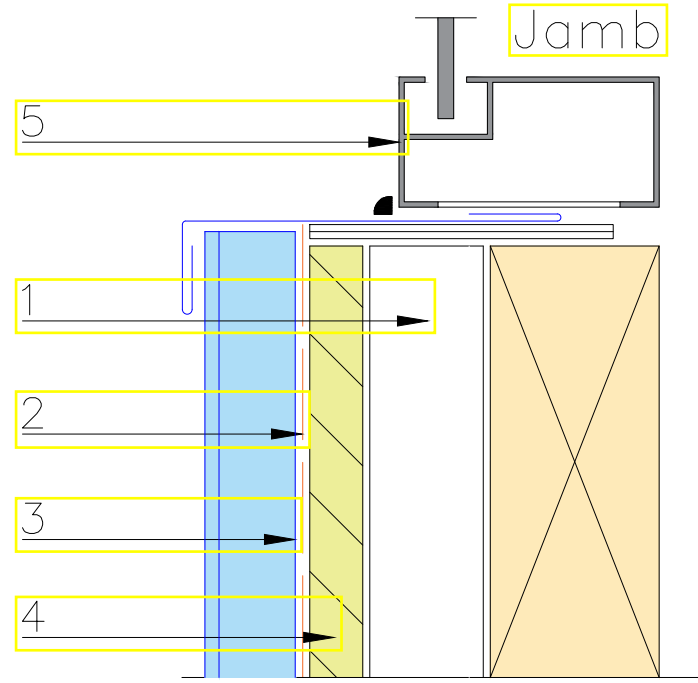

Zinc Roofing Company Pty Ltd TA Euroclad
 ABN: 45 297 371 439
 3/328 Brisbane Road Arundel QLD 4214
 Tel: (07) 5537 1937
 Email: info@euroclad.com.au

NOTES:
 1. All dimensions shown are in millimeters unless otherwise stated.
 2. Figured dimensions to be used in preference to scaled dimensions.
 3. Ensure compliance with all relevant sections of current building regulations.
 4. Any discrepancies found on drawings to be reported immediately to Euroclad.
 5. Not a shop drawing. For illustration purposes only.

DRAWING #
 SS-HC-08

REVISION #
 0

SYSTEM
 Single Lock Standing Seam Horizontal

TITLE
 Window Surroundings

DATE: N/A DRN: NP

JOB # 0 PROJ # 0

SCALE NTS